



REPUBLIC OF
GAMERS

PG258Q USER MANUAL

ASUS

HDMI™
HIGH DEFINITION MULTIMEDIA INTERFACE

First Edition

November 2016

Copyright © 2016 ASUSTeK COMPUTER INC. All Rights Reserved.

No part of this manual, including the products and software described in it, may be reproduced, transmitted, transcribed, stored in a retrieval system, or translated into any language in any form or by any means, except documentation kept by the purchaser for backup purposes, without the express written permission of ASUSTeK COMPUTER INC. ("ASUS").

Product warranty or service will not be extended if: (1) the product is repaired, modified or altered, unless such repair, modification or alteration is authorized in writing by ASUS; or (2) the serial number of the product is defaced or missing.

ASUS PROVIDES THIS MANUAL "AS IS" WITHOUT WARRANTY OF ANY KIND, EITHER EXPRESS OR IMPLIED, INCLUDING BUT NOT LIMITED TO THE IMPLIED WARRANTIES OR CONDITIONS OF MERCHANTABILITY OR FITNESS FOR A PARTICULAR PURPOSE. IN NO EVENT SHALL ASUS, ITS DIRECTORS, OFFICERS, EMPLOYEES OR AGENTS BE LIABLE FOR ANY INDIRECT, SPECIAL, INCIDENTAL, OR CONSEQUENTIAL DAMAGES (INCLUDING DAMAGES FOR LOSS OF PROFITS, LOSS OF BUSINESS, LOSS OF USE OR DATA, INTERRUPTION OF BUSINESS AND THE LIKE), EVEN IF ASUS HAS BEEN ADVISED OF THE POSSIBILITY OF SUCH DAMAGES ARISING FROM ANY DEFECT OR ERROR IN THIS MANUAL OR PRODUCT.

SPECIFICATIONS AND INFORMATION CONTAINED IN THIS MANUAL ARE FURNISHED FOR INFORMATIONAL USE ONLY, AND ARE SUBJECT TO CHANGE AT ANY TIME WITHOUT NOTICE, AND SHOULD NOT BE CONSTRUED AS A COMMITMENT BY ASUS. ASUS ASSUMES NO RESPONSIBILITY OR LIABILITY FOR ANY ERRORS OR INACCURACIES THAT MAY APPEAR IN THIS MANUAL, INCLUDING THE PRODUCTS AND SOFTWARE DESCRIBED IN IT.

Products and corporate names appearing in this manual may or may not be registered trademarks or copyrights of their respective companies, and are used only for identification or explanation and to the owners' benefit, without intent to infringe.

Contents

Notices.....	iv
Safety information	v
Care & Cleaning	vi
Takeback Services.....	vii

Chapter 1: Product introduction

1.1	Welcome!	1-1
1.2	Package contents.....	1-1
1.3	Monitor introduction.....	1-2
1.3.1	Front/side view	1-2
1.3.2	Back view.....	1-3
1.3.3	GamePlus Function	1-4
1.3.4	GameVisual Function.....	1-5

Chapter 2: Setup

2.1	Assembling the monitor arm/base	2-1
2.2	Cable management	2-2
2.3	Adjusting the monitor.....	2-3
2.4	Detaching the arm (for VESA wall mount).....	2-4
2.5	Connecting the cables.....	2-5
2.6	Turning on the monitor.....	2-5

Chapter 3: General instructions

3.1	OSD (On-Screen Display) menu	3-1
3.1.1	How to reconfigure.....	3-1
3.1.2	OSD function introduction.....	3-1
3.2	Specifications summary	3-5
3.3	Troubleshooting (FAQ).....	3-6
3.4	Supported operating mode	3-7

Notices

Federal Communications Commission Statement

This device complies with Part 15 of the FCC Rules. Operation is subject to the following two conditions:

- This device may not cause harmful interference, and
- This device must accept any interference received including interference that may cause undesired operation.

This equipment has been tested and found to comply with the limits for a Class B digital device, pursuant to Part 15 of the FCC Rules. These limits are designed to provide reasonable protection against harmful interference in a residential installation. This equipment generates, uses and can radiate radio frequency energy and, if not installed and used in accordance with manufacturer's instructions, may cause harmful interference to radio communications. However, there is no guarantee that interference will not occur in a particular installation. If this equipment does cause harmful interference to radio or television reception, which can be determined by turning the equipment off and on, the user is encouraged to try to correct the interference by one or more of the following measures:

- Reorient or relocate the receiving antenna.
- Increase the separation between the equipment and receiver.
- Connect the equipment to an outlet on a circuit different from that to which the receiver is connected.
- Consult the dealer or an experienced radio/TV technician for help.



The use of shielded cables for connection of the monitor to the graphics card is required to assure compliance with FCC regulations. Changes or modifications to this unit not expressly approved by the party responsible for compliance could void the user's authority to operate this equipment.

Canadian Department of Communications Statement

This digital apparatus does not exceed the Class B limits for radio noise emissions from digital apparatus set out in the Radio Interference Regulations of the Canadian Department of Communications.

This class B digital apparatus complies with Canadian ICES-003.

This Class B digital apparatus meets all requirements of the Canadian Interference - Causing Equipment Regulations.

Cet appareil numérique de la classe B respecte toutes les exigences du Règlement sur le matériel brouiller du Canada.



Safety information

- Before setting up the monitor, carefully read all the documentation that came with the package.
- To prevent fire or shock hazard, never expose the monitor to rain or moisture.
- Never try to open the monitor cabinet. The dangerous high voltages inside the monitor may result in serious physical injury.
- If the power supply is broken, do not try to fix it by yourself. Contact a qualified service technician or your retailer.
- Before using the product, make sure all cables are correctly connected and the power cables are not damaged. If you detect any damage, contact your dealer immediately.
- Slots and openings on the back or top of the cabinet are provided for ventilation. Do not block these slots. Never place this product near or over a radiator or heat source unless proper ventilation is provided.
- The monitor should be operated only from the type of power source indicated on the label. If you are not sure of the type of power supply to your home, consult your dealer or local power company.
- Use the appropriate power plug which complies with your local power standard.
- Do not overload power strips and extension cords. Overloading can result in fire or electric shock.
- Avoid dust, humidity, and temperature extremes. Do not place the monitor in any area where it may become wet. Place the monitor on a stable surface.
- Unplug the unit during a lightning storm or if it will not be used for a long period of time. This will protect the monitor from damage due to power surges.
- Never push objects or spill liquid of any kind into the slots on the monitor cabinet.
- To ensure satisfactory operation, use the monitor only with UL listed computers which have appropriate configured receptacles marked between 100-240V AC.
- If you encounter technical problems with the monitor, contact a qualified service technician or your retailer.
- Adjustment of the volume control as well as the equalizer to other settings than the center position may increase the ear-/headphones output voltage and therefore the sound pressure level.
- The adapter is only used for this monitor, do not use it for other purpose.
Your device uses one of the following power supplies:
- Manufacturer: Delta Electronics Inc., Model: ADP-65GD B



This symbol of the crossed out wheeled bin indicates that the product (electrical, electronic equipment, and mercury-containing button cell battery) should not be placed in municipal waste. Please check local regulations for disposal of electronic products.

Care & Cleaning

- Before you lift or reposition your monitor, it is better to disconnect the cables and power cord. Follow the correct lifting techniques when positioning the monitor. When lifting or carrying the monitor, grasp the edges of the monitor. Do not lift the display by the stand or the cord.
- Cleaning. Turn your monitor off and unplug the power cord. Clean the monitor surface with a lint-free, non-abrasive cloth. Stubborn stains may be removed with a cloth dampened with mild cleaner.
- Avoid using a cleaner containing alcohol or acetone. Use a cleaner intended for use with the monitor. Never spray cleaner directly on the screen, as it may drip inside the monitor and cause an electric shock.

The following symptoms are normal with the monitor:

- The screen may flicker during the initial use due to the nature of the fluorescent light. Turn off the Power Switch and turn it on again to make sure that the flicker disappears.
- You may find slightly uneven brightness on the screen depending on the desktop pattern you use.
- When the same image is displayed for hours, an afterimage of the previous screen may remain after switching the image. The screen will recover slowly or you can turn off the Power Switch for hours.
- When the screen becomes black or flashes, or cannot work anymore, contact your dealer or service center to fix it. Do not repair the screen by yourself!

Conventions used in this guide



WARNING: Information to prevent injury to yourself when trying to complete a task.



CAUTION: Information to prevent damage to the components when trying to complete a task.



IMPORTANT: Information that you **MUST** follow to complete a task.



NOTE: Tips and additional information to aid in completing a task.

Where to find more information

Refer to the following sources for additional information and for product and software updates.

1. **ASUS websites**

The ASUS websites worldwide provide updated information on ASUS hardware and software products. Refer to <http://www.asus.com>

2. **Optional documentation**

Your product package may include optional documentation that may have been added by your dealer. These documents are not part of the standard package.

Takeback Services

ASUS recycling and takeback programs come from our commitment to the highest standards for protecting our environment. We believe in providing solutions for our customers to be able to responsibly recycle our products, batteries and other components as well as the packaging materials.

Please go to <http://csr.asus.com/english/Takeback.htm> for detail recycling information in different region.

1.1 Welcome!

Thank you for purchasing the ASUS® LCD monitor!

The latest widescreen LCD monitor from ASUS provides a broader, brighter and crystal-clear display, plus a host of features that enhance your viewing experience.

With these features, you can enjoy the convenience and delightful visual experience that the monitor brings to you!

1.2 Package contents

Check your package for the following items:

- ✓ LCD monitor
- ✓ Monitor base
- ✓ Driver and Manual disc
- ✓ Quick start guide
- ✓ Warranty card
- ✓ Power adapter
- ✓ Power cord
- ✓ DP cable
- ✓ HDMI cable
- ✓ USB cable
- ✓ LED projection cover and changeable films
- ✓ Input/Output port cover



If any of the above items is damaged or missing, contact your retailer immediately.



Select "Level 1/Level 2/ Level 3" when you see the message "LIGHT IN MOTION ON/OFF" appears if you want to turn on the red light on the base. Select "Level 0" if you want it to turn off. If you disable this function but later wish to reactivate it, please use the OSD menu to turn it on.



If no signal is detected for around 12 minutes, the monitor automatically enters saving mode.







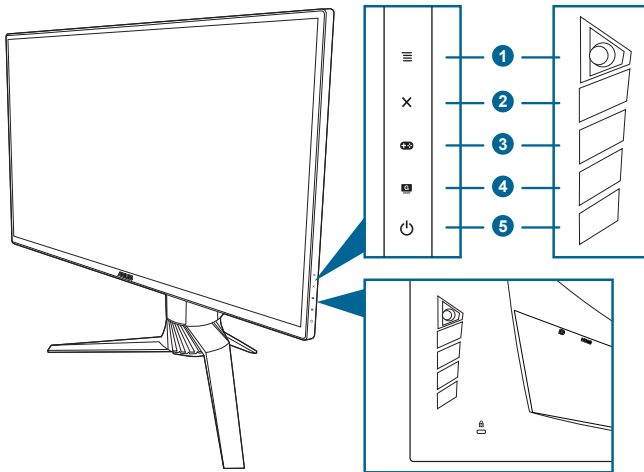

It is recommended that you set the DisplayPort Deep Sleep and HDMI Deep Sleep functions to "OFF".

1.3 Monitor introduction

1.3.1 Front/side view



1.  (5-way) button:
 - Turns on the OSD menu. Enacts the selected OSD menu item.
 - Increases/Decreases values or moves your selection up/down/left/right.
 - Turns on the OSD menu when the monitor enters standby mode or displays the "NO SIGNAL" message.
2.  button
 - Exits the OSD menu item.
 - Turns on the OSD menu when the monitor enters standby mode or displays the "NO SIGNAL" message.
3.  button:
 - GamePlus hotkey. Move the  button up/down to select and press  to confirm the function needed.
 - Turns on the OSD menu when the monitor enters standby mode or displays the "NO SIGNAL" message.
4.  button
 - GameVisual hotkey. This function contains 6 sub-functions you can select for your preference.
 - Turns on the OSD menu when the monitor enters standby mode or displays the "NO SIGNAL" message.
5.  Power button/power indicator

- Turns the monitor on/off.
- The color definition of the power indicator is as the below table.

Status	Description
White	ON
Amber flashing	Entering standby mode
Amber	Standby mode/No signal
OFF	OFF
Red	G-SYNC
Green	3D
Yellow	ULMB

1.3.2 Back view

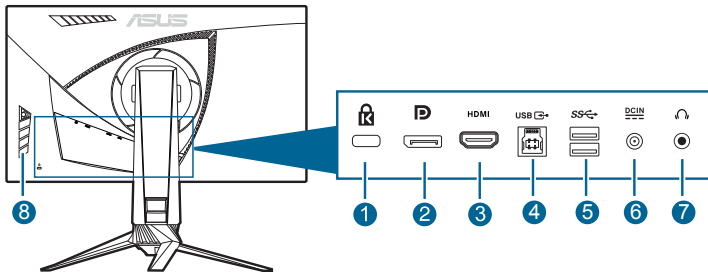







1. **Kensington lock slot.**
2. **DisplayPort.** This port is for connection for a DisplayPort compatible device.
3. **HDMI port.** This port is for connection with an HDMI compatible device.
4. **USB 3.0 upstream port.** This port is for connection with a USB upstream cable. The connection enables the USB ports on the monitor.
5. **USB 3.0 downstream ports.** These ports are for connection with USB devices, such as USB keyboard/mouse, USB flash drive, etc.
6. **DC-IN port.** This port connects the power cord.
7. **Earphone jack.** This port is only available when an HDMI/DisplayPort cable is connected.
8. **Control buttons.**

1.3.3 GamePlus Function

The GamePlus function provides a toolkit and creates a better gaming environment for users when playing different types of games. The crosshair overlay with four different crosshair options lets you choose the one that best suits the game you're playing. There's also an onscreen timer you can position on the left of the display so you can keep track of the elapsed gaming time; while the FPS (frames per second) counter lets you know how smooth the game is running. Display Alignment displays alignment lines on 4 sides of the screen, serving as an easy and handy tool for you to line up multiple monitors perfectly.

To active GamePlus:

1. Press the GamePlus hotkey.
2. Move the  button up/down to select among different functions.
3. Press the  button or move the  button right to confirm the function you choose, and move the  button up/down to navigate through the settings. Move the  button left to go back, off, and exit.
4. Highlight the desired setting and press the  button to activate it. Press the  button to inactivate it.

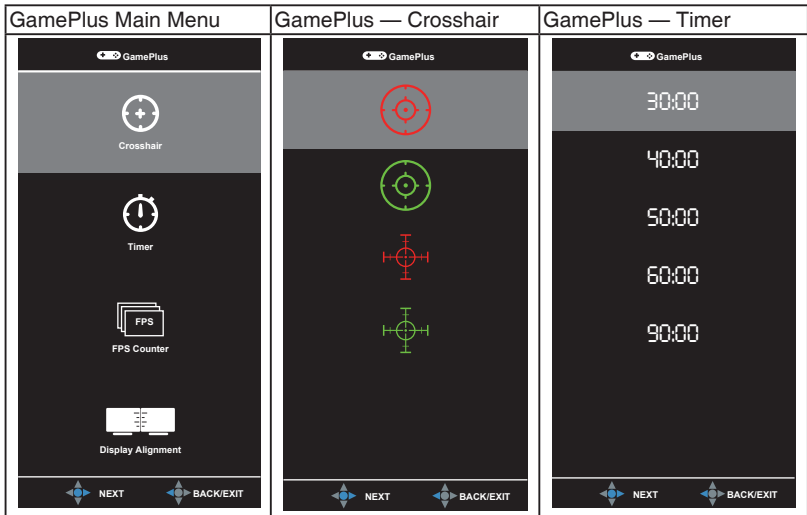

1.3.4 GameVisual Function

The GameVisual function helps you select among different picture modes in a convenient way.

To active GameVisual:

Press the GameVisual hotkey repeatedly to select.

- **Scenery Mode:** This is the best choice for scenery photo displaying with GameVisual™ Video intelligence Technology.
- **Racing Mode:** This is the best choice for racing game playing with GameVisual™ Video intelligence Technology.
- **Cinema Mode:** This is the best choice for movie watching with GameVisual™ Video intelligence Technology.
- **RTS/RPG Mode:** This is the best choice for Real-Time Strategy (RTS)/ Role-Playing Game (RPG) playing with GameVisual™ Video intelligence Technology.
- **FPS Mode:** This is the best choice for First Person Shooter game playing with GameVisual™ Video intelligence Technology.
- **sRGB Mode:** This is the best choice for viewing photos and graphics from PCs.



-
- In the Racing mode, the following function(s) are not user-configurable: Saturation.
 - In the sRGB mode, the following function(s) are not user-configurable: Saturation, Color Temp., Brightness, Contrast, Gamma.
 - In the Scenery and Cinema modes, the following function(s) are not user-configurable: Gamma, Dark Boost.
-

2.1 Assembling the monitor arm/base

1. Insert the base into the arm.
2. Fix the base to the arm by fastening the bundled screw.
3. Attach the LED projection cover to the stand.

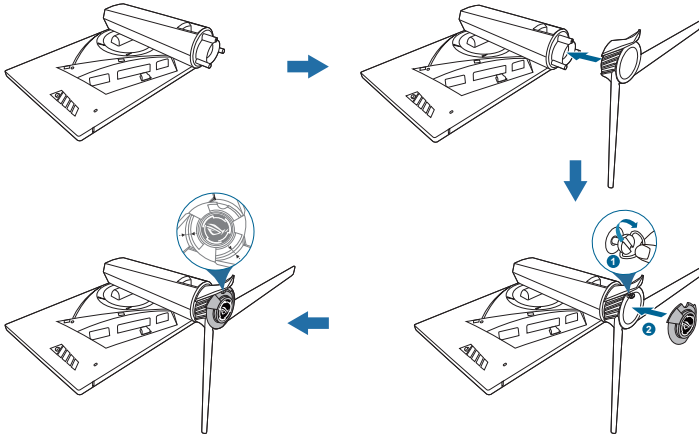

We recommend that you cover the table surface with soft cloth to prevent damage to the monitor.

To change the film on the LED projection cover, follow the illustration below.

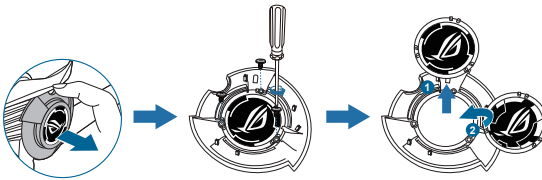

2.2 Cable management

You can organize the cables with the help of the input/output port cover.

- **Arranging the cables**

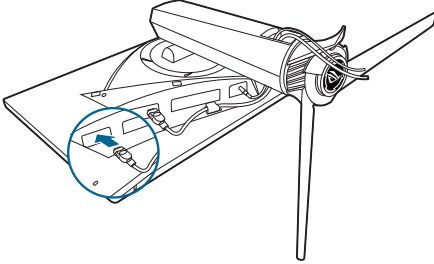

- **Using the input/output port cover:** the cover can be attached or detached.

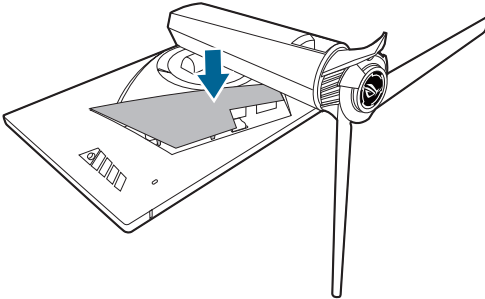

2.3 Adjusting the monitor

- For optimal viewing, we recommend that you look at the full face of the monitor, then adjust the monitor to the angle that is most comfortable for you.
- Hold the stand to prevent the monitor from falling when you change its angle.
- The recommended adjusting angle is $+20^{\circ}$ to -5° (for tilt)/ $+50^{\circ}$ to -50° (for swiveling)/ $\pm 120\text{mm}$ (for height adjustment)/ 90° (for portrait view).

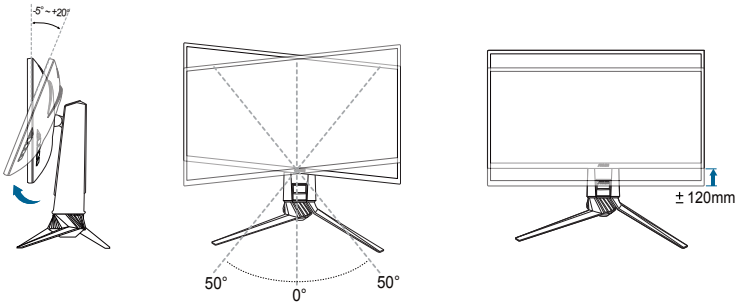

It is normal that the monitor slightly shakes while you adjust the viewing angle.

Pivoting the monitor

1. Lift the monitor to the highest position.
2. Tilt the monitor to its maximum angle.
3. Pivot the monitor clockwise to the angle you need.

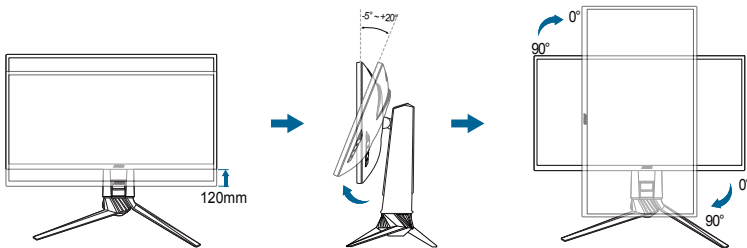

It is normal that the monitor slightly shakes while you adjust the viewing angle.

2.4 Detaching the arm (for VESA wall mount)

The detachable arm of this monitor is specially designed for VESA wall mount.

To detach the arm:

1. Have the front of the monitor face down on a table.
2. Remove the covers on where the monitor and the arm meet.
3. Loosen the four screws on the back of the monitor and remove the arm/base.

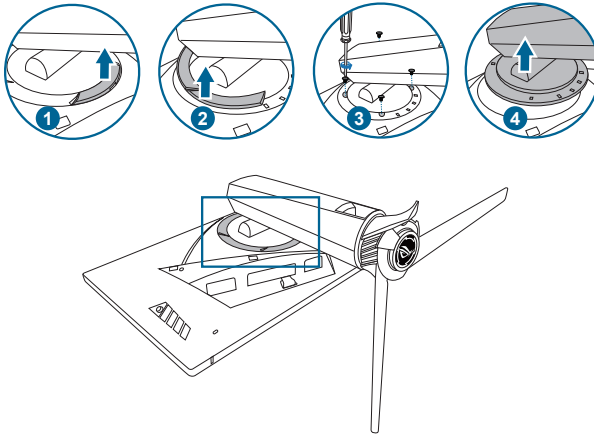

We recommend that you cover the table surface with soft cloth to prevent damage to the monitor.



- The VESA wall mount kit (100 x 100 mm) is purchased separately.
 - Use only the UL Listed Wall Mount Bracket with minimum weight/load 22.7kg (Screw size: M4 x 10 mm)
-

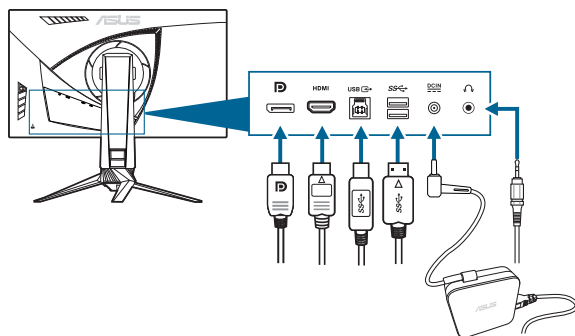

2.5 Connecting the cables

Connect the cables as the following instructions:



- **To connect the power cord:**
 - a. Connect the power adapter securely to the monitor's DC input.
 - b. Connect one end of the power cord to the power adapter and the other end to a power outlet.
- **To connect the DisplayPort/HDMI cable:**
 - a. Plug one end of the DisplayPort/HDMI cable to the monitor's DisplayPort/HDMI port.
 - b. Connect the other end of the DisplayPort/HDMI cable to your computer's DisplayPort/HDMI port.
- **To use the earphone:** connect the end with plug type to the monitor's earphone jack when an HDMI or DisplayPort signal is fed.
- **To use the USB 3.0 ports:** Take the supplied USB 3.0 cable, and plug the smaller end (type B) of the USB upstream cable to the monitor's USB upstream port, and the larger end (type A) to your computer's USB 3.0 port. Make sure your computer is installed with the latest Windows 7/Windows 8.1/Windows 10 operating system. That will enable the USB ports on the monitor to work.









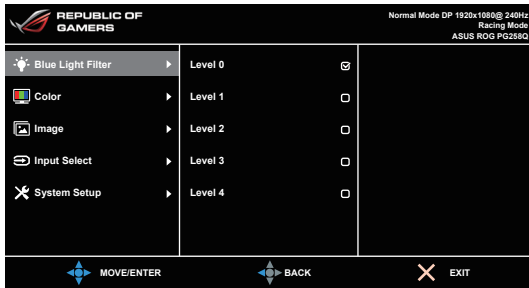







2.6 Turning on the monitor

Press the power button . See page 1-2 for the location of the power button. The power indicator  lights up in white to show that the monitor is ON.

3.1 OSD (On-Screen Display) menu

3.1.1 How to reconfigure



1. Press the  () button to activate the OSD menu.
2. Move the  () button up/down to navigate through the functions. Highlight the desired function and press the  () button to activate it. If the function selected has a sub-menu, move the  () button up/down again to navigate through the sub-menu functions. Highlight the desired sub-menu function and press the  () button or move the  () button right to activate it.
3. Move the  () button up/down to change the settings of the selected function.
4. To exit and save the OSD menu, press the  button or move the  () left repeatedly until the OSD menu disappears. To adjust other functions, repeat steps 1-3.

3.1.2 OSD function introduction

1. Blue Light Filter

In this function, you can adjust the blue light filter level.

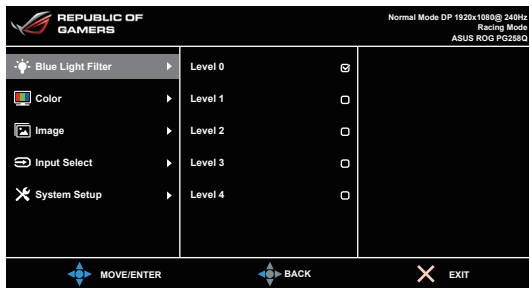

- **Level 0:** No change.

- **Level 1~4:** The higher the level, the less blue light is scattered. When Blue Light Filter is activated, the default settings of Racing Mode will be automatically imported. Between Level 1 to Level 3, the Brightness function is user-configurable. Level 4 is optimized setting. It is compliance with TUV Low Blue Light Certification. The Brightness function is not user-configurable.



To alleviate eye strain, rest your eyes for fifteen minutes for every two hours spent in front of the screen. Frequent blinking and eye exercise helps keep your eye moist to prevent them from drying out. In addition, your computer screen should be placed 20 to 28 inches (50-70cm) away from you.

2. Color

You can adjust Brightness, Contrast, Saturation, Color temperature and Gamma from this menu.

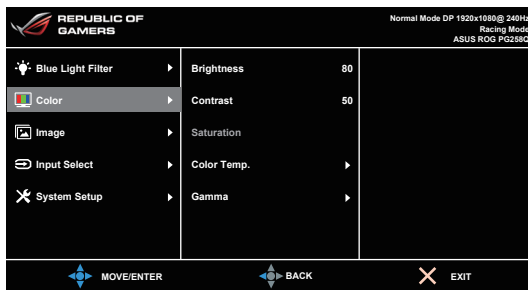

- **Brightness:** the adjusting range is from 0 to 100. When NVIDIA 3D vision is enabled, **Brightness** will be changed to **NVIDIA® LightBoost™**. You can enjoy twice the brightness of conventional 3D technology in 3D mode with zero increase in total energy consumption*



*Compatible with the NVIDIA 3D Vision® 2 kit. To activate NVIDIA 3D function, turn off Gsync first and make sure that the input source is DisplayPort.

- **Contrast:** the adjusting range is from 0 to 100.
- **Saturation:** The adjusting range is from 0 to 100.
- **Color Temp.:** contains 4 modes including Cool, Normal, Warm, and User Mode.
- **Gamma:** allows you to set the color mode to 2.4, 2.2 or 1.8.

3. Image

You can adjust OD, Adaptive Contrast Control, Dark Boost and ULMB from this menu.

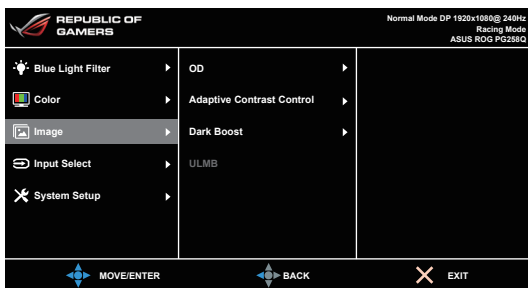

- **OD:** Improves the gray level response time of the LCD panel.
- **Adaptive Contrast Control:** Dynamically adjusts the monitor's contrast level to reveal details in every part of an image especially when an image's contrast is low. The strength level of the adaptive contrast control is adjustable to Enable, Strength or Limit.
- **Dark Boost:** Dark color enhancement adjusts monitor's gamma curve to enrich the dark tones in an image making dark scenes and objects much easier to see.
- **ULMB (Ultra Low Motion Blur)** (only for DisplayPort input): Adjusts the level of motion blur reduction. This function is available when the refresh rate is 100Hz, 120Hz or 144Hz.

4. Input Select

In this function, you can select your desired input source.

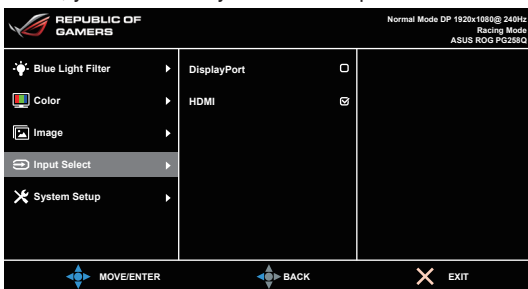

5. System Setup

Allows you to adjust the system.

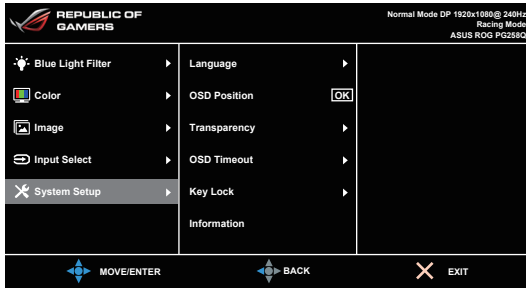

- **Language:** There are 21 languages for your selection, including English, French, German, Italian, Spanish, Dutch, Portuguese, Russian, Czech, Croatian, Polish, Romanian, Hungarian, Turkish, Simplified Chinese, Traditional Chinese, Japanese, Korean, Thai, Indonesia, Persian.
- **OSD Position:** Adjusts the horizontal position (H-Position)/the vertical position (V-Position) of the OSD.
- **Transparency:** Adjusts the OSD background from opaque to transparent.
- **OSD Timeout:** Adjusts the OSD timeout from 10 to 120 seconds.
- **Keylock:** To disable all function keys. Press **X** over 5 seconds to cancel the key lock function.
- **Information:** Shows the monitor information.
- **LIGHT IN MOTION:** Selects the brightness level of the light on the stand. The adjusting range is from Level 0 to 3.
- **Sound:**
 - * **Volume:** the adjusting range is from 0 to 100.
 - * **Mute:** toggles the monitor sound between on and off.
- **All Reset:** "Yes" allows you to restore the default settings.
- **DisplayPort Deep Sleep:** puts the DisplayPort port into deep sleep.
- **HDMI Deep Sleep:** puts the HDMI port into deep sleep.



If the monitor cannot wake up after going into deep sleep, do one of the followings:

- Press any button (except ) on the monitor to wake it up.
- Disable the Deep Sleep function. (Recommended)

3.2 Specifications summary

Panel Type	TFT LCD
Panel size	24.5"W (16:9, 62.2 cm) wide screen
Max. Resolution	1920 x 1080
Pixel pitch	0.2832 mm x 0.2802 mm
Brightness (Typ.)	400 cd/m ²
Contrast Ratio (Typ.)	1000:1
Viewing angle(H/V) CR>10	170°/160°
Display colors	16.7 M
Response time	1 ms (Gray to Gray)
Color temperature selection	4 color temperatures
Analog input	No
Digital input	DisplayPort v1.2 x 1, HDMI v1.4
Earphone jack	Yes
Audio input	No
Speaker (Built-in)	No
USB 3.0 port	Upstream x 1, Downstream x 2
Colors	Black
Power LED	White (On)/Amber (Standby)
Tilt	+20° ~ -5°
Pivot	90° (clockwise)
Swivel	+50° ~ -50°
Height adjustment	120 mm
VESA wall mount	100 x 100 mm
Kensington lock	Yes
Voltage rating	AC: 100~240V DC: 19V, 3.42A (AC adapter)
Power consumption	Power On: < 65 W, Standby: < 0.5 W, Power Off: < 0.5 W
Temperature (Operating)	0°C~40°C
Temperature (Non-operating)	-20°C~+60°C
Dimensions (W x H x D)	564.1 x 383.7 x 253.7 mm (lowest) 564.1 x 503.7 x 253.7 mm (highest) 661 x 443 x 239 mm (package)
Weight (Esti.)	5.6 kg (Net); 7.9 kg (Gross)
Multi-languages	21 languages (English, French, German, Italian, Spanish, Dutch, Portuguese, Russian, Czech, Croatian, Polish, Romanian, Hungarian, Turkish, Simplified Chinese, Traditional Chinese, Japanese, Korean, Thai, Indonesia, Persian)

Accessories	DP cable, HDMI cable, USB cable, power adapter, power cord, Driver and Manual disc, Quick start guide, warranty card, LED projection cover and changeable films, Input/Output port cover
Compliance and Standards	CB, CE, CU, CCC, UL/cUL, FCC, RCM, BSMI, VCCI, RoHS, WEEE, J-MOSS, ErP, PSE, CEL, Windows 7 WHQL, Windows 8.1 WHQL, Windows 10 WHQL, KCC, E-Standby, TUV-Flicker Free, TUV-Low Blue Light, UkrSEPRO, MEPS

***Specifications are subject to change without notice.**

3.3 Troubleshooting (FAQ)

Problem	Possible Solution
Power LED is not ON	<ul style="list-style-type: none"> • Press the  button to check if the monitor is in the ON mode. • Check if the power cord is properly connected to the monitor and the power outlet.
The power LED lights white and there is no screen image	<ul style="list-style-type: none"> • Check if the monitor and the computer are in the ON mode. • Make sure the signal cable is properly connected the monitor and the computer. • Inspect the signal cable and make sure none of the pins are bent. • Connect the computer with another available monitor to check if the computer is properly working.
Screen image is too light or dark	<ul style="list-style-type: none"> • Adjust the Contrast and Brightness settings via OSD.
Screen image bounces or a wave pattern is present in the image	<ul style="list-style-type: none"> • Make sure the signal cable is properly connected to the monitor and the computer. • Move electrical devices that may cause electrical interference.
Screen image has color defects (white does not look white)	<ul style="list-style-type: none"> • Inspect the signal cable and make sure that none of the pins are bent. • Perform All Reset via OSD. • Adjust the R/G/B color settings or select the Color Temperature via OSD.

3.4 Supported operating mode

HDMI input

Resolution Frequency	Refresh Rate
640 x 480	60Hz
720 x 480	60Hz
720 x 576	50Hz
800 x 600	60Hz
1024 x 768	60Hz
1280 x 720	50Hz
1280 x 720	60Hz
1920 x 1080	50Hz
1920 x 1080	60Hz

Note:

Do not support interlace.

DisplayPort input

Resolution Frequency	Refresh Rate
640 x 480	60Hz
800 x 600	60Hz
1024 x 768	60Hz
1920 x 1080	60Hz
1920 x 1080	100Hz
1920 x 1080	120Hz
1920 x 1080	144Hz
1920 x 1080	200Hz
1920 x 1080	240Hz

Note:

Do not support interlace.

G-SYNC (only for DisplayPort input) supported NVIDIA GPUs: NVIDIA GeForce GTX 650Ti BOOST GPU or higher. For other GPUs, please contact the manufactures to see if they are compatible.

For 240Hz, only the following GPUs are supported: GeForce GTX 745(OEM), GeForce GTX 750, GeForce GTX 750Ti, GeForce GTX 780, GeForce GTX 780Ti, GeForce GTX TITAN, GeForce GTX TITAN Black, GeForce GTX TITAN Z, GeForce GTX 960, GeForce GTX 970, GeForce GTX 980, GeForce GTX 980Ti, GeForce GTX TITAN X, GeForce GTX 1060, GeForce GTX 1070, GeForce GTX 1080. For other GPUs, please contact the manufactures to see if they are compatible.

System Requirements for NVIDIA 3D vision

- Microsoft® Windows® Vista 32/64-bit or Windows 7 32/64-bit.

- Intel® Core™2 Duo or AMD Athlon™ X2 CPU or higher.
- 1GB of system memory (2GB is recommended)
- 100 MB free disk space.

DECLARATION OF CONFORMITY

Per FCC Part 2 Section 2. 1077(a)



Responsible Party Name: **Asus Computer International**

Address: **800 Corporate Way, Fremont, CA 94539.**

Phone/Fax No: **(510)739-3777/(510)608-4555**

hereby declares that the product

Product Name : **LCD Monitor**

Model Number : **PG258Q, PG258QE, PG258QR, PG258Q-P,
PG258QE-P, PG258QR-P, PG258Q-J, PG258QE-J,
PG258QR-J**

Conforms to the following specifications:

FCC Part 15, Subpart B, Unintentional Radiators

Supplementary Information:

This device complies with part 15 of the FCC Rules. Operation is subject to the following two conditions: (1) This device may not cause harmful interference, and (2) this device must accept any interference received, including interference that may cause undesired operation.

Representative Person's Name : **Steve Chang / President**

A handwritten signature in blue ink that reads "Steve Chang". The signature is written in a cursive style and is placed over a light blue rectangular background.

Signature :

Date : **Dec. 02, 2016**

EU Declaration of Conformity

We, the undersigned,

Manufacturer:	ASUSTeK COMPUTER INC.
Address:	4F, No. 150, LI-TE Rd., PEITOU, TAIPEI 112, TAIWAN
Authorized representative in Europe:	ASUS COMPUTER GmbH
Address, City:	HARKORT STR. 21-23, 40880 RATINGEN
Country:	GERMANY

declare the following apparatus:

Product name :	LCD Monitor
Model name :	PG258Q, PG258QE, PG258QR, PG258Q-P, PG258QE-P, PG258QR-P, PG258Q-J, PG258QE-J, PG258QR-J

The object of the declaration described above is in conformity with the relevant Union harmonisation legislation:

EMC – Directive 2014/30/EU

<input checked="" type="checkbox"/> EN 55032:2012+AC:2013 <input checked="" type="checkbox"/> EN 61000-3-2:2014 <input type="checkbox"/> EN 55032:2012+AC:2013	<input checked="" type="checkbox"/> EN 55024:2010+A1:2015 <input checked="" type="checkbox"/> EN 61000-3-3:2013 <input type="checkbox"/> EN 55020:2007+A11:2011
--	---

R&TTE – Directive 1999/5/EC

<input type="checkbox"/> EN 300 328 V1.9.1(2015-02) <input type="checkbox"/> EN 300 440-1 V1.6.1(2010-08) <input type="checkbox"/> EN 300 440-2 V1.4.1(2010-08) <input type="checkbox"/> EN 301 511 V12.1.1(2015-06) <input type="checkbox"/> EN 301 908-1 V7.1.1(2015-03) <input type="checkbox"/> EN 301 908-2 V6.2.1(2013-10) <input type="checkbox"/> EN 301 908-13 V6.2.1(2014-02) <input type="checkbox"/> EN 301 893 V1.8.1(2015-03) <input type="checkbox"/> EN 300 330-2 V1.6.1(2015-03) <input type="checkbox"/> EN 50360:2001/A1:2012 <input type="checkbox"/> EN 62479:2010 <input type="checkbox"/> EN 62311:2008	<input type="checkbox"/> EN 301 489-1 V1.9.2(2011-09) <input type="checkbox"/> EN 301 489-3 V1.6.1(2013-12) <input type="checkbox"/> EN 301 489-4 V2.2.1(2015-05) <input type="checkbox"/> EN 301 489-7 V1.3.1(2005-11) <input type="checkbox"/> EN 301 489-9 V1.4.1(2007-11) <input type="checkbox"/> EN 301 489-17 V2.2.1(2012-09) <input type="checkbox"/> EN 301 489-24 V1.5.1(2010-09) <input type="checkbox"/> EN 301 357-2 V1.4.1(2008-11) <input type="checkbox"/> EN 302 291-2 V1.1.1(2005-07) <input type="checkbox"/> EN 302 623 V1.1.1(2009-01) <input type="checkbox"/> EN 50566:2013/AC:2014 <input type="checkbox"/> EN 50385:2002
---	--

LVD – Directive 2014/35/EU

<input checked="" type="checkbox"/> EN 60950-1: 2006 / A12: 2011 <input checked="" type="checkbox"/> EN 60950-1: 2006 / A2: 2013	<input type="checkbox"/> EN 60065:2002 / A12: 2011
---	--

Ecodesign – Directive 2009/125/EC

<input checked="" type="checkbox"/> Regulation (EC) No. 1275/2008 <input type="checkbox"/> Regulation (EC) No. 642/2009	<input checked="" type="checkbox"/> Regulation (EC) No. 278/2009 <input type="checkbox"/> Regulation (EU) No. 617/2013
--	---

RoHS – Directive 2011/65/EU

Ver. 161201

CE marking

Equipment Class 1



(EU conformity marking)



Signature

Jerry Shen

Printed Name

CEO

Position

Taipei, Taiwan

Place of issue

2/12/2016

Date of issue

2016

Year CE marking was first affixed

ASUS

